



Cheego

Smart Baby Monitor

CCA3 - W / User Guide



WHAT'S IN THE BOX



Cheego Camera
x 1



Cable Covers
x 6



Power Adapter
x 1



Mounting Template
x 1



Mounting Bracket & Level
x 1



Self Drilling Drywall Anchors
x 3



Drywall Anchors
x 3



Screws
x 3



User Guide
x 1

PRODUCT OVERVIEW

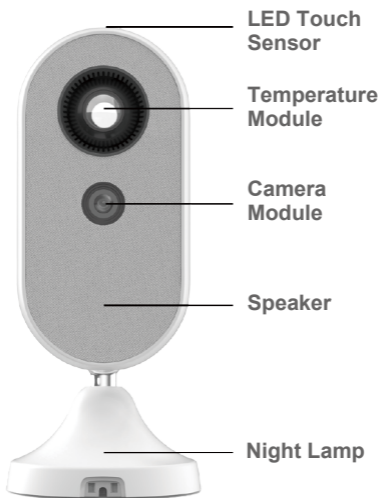

SAFETY

WARNING: Strangulation Hazard—Children have STRANGLED in cords. NEVER attempt to use cord without the protective covering. Check protective covering before each use to ensure that the cord is not exposed to your child. Immediately discontinue use if protective covering is damaged or broken.

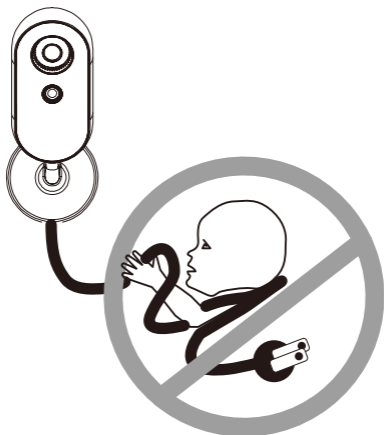

- This device is designed to be mounted behind a standard crib and against the wall.
- Adult assembly is required. Keep small parts away from children when assembling.
- This product cannot replace adult supervision. Ensure your child's health by checking on him/her regularly.
- This device is designed for indoor use only.
- This product and its packaging are not toys. Do not allow children to play with them.
- Falling warning---In order to prevent products fell to hurt, be sure to install the monitor in a stable location, tighten the screws, securely monitor your device.
- Make sure the camera could capture the baby's facial image clearly after the installation.
- accept any interference received,
- tested and found to comply with the pursuant to Part 15 of the FCC Rules.

Installation

Position your crib against the wall where you will mount Cheego Camera.

Be sure to check that there are no studs in the center of the crib and that the power outlet is out of your child's reach.

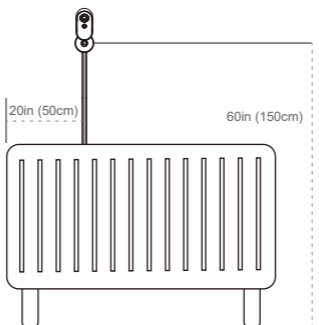

1. Using the included Mounting Template, find the 20" (50cm) position from the headboard of the crib and mark it (as ①) on your wall. Once complete, move the crib out of your way.

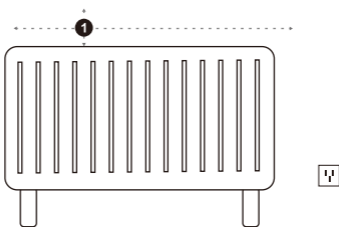

2. Pull straight and vertical the Mounting Template, then align with the mark ①. Once in position, make a mark on your wall at 60" (150cm) (as ②).

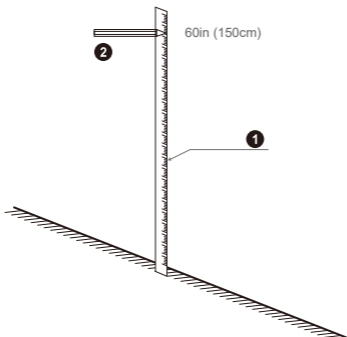

3. Align the screw holes at the lowest part of the mounting bracket (mark ②) then adjust it using the built-in level. Once level, mark the wall through the two top holes in the bracket (as ③ ④).

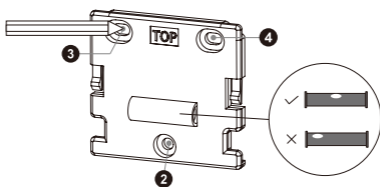

4. Drill 1/4" (6mm) holes in the three marked spots (② ③ ④).

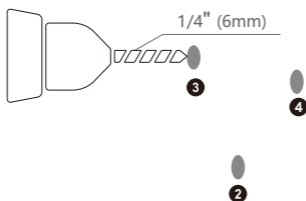

5. Insert three anchors until flush with wall.

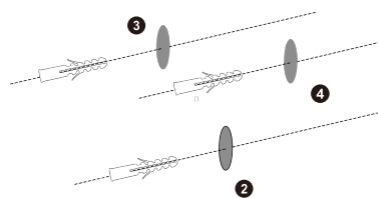

6. Align the mounting bracket with the three anchors, and insert screws into the anchors and screw in halfway.

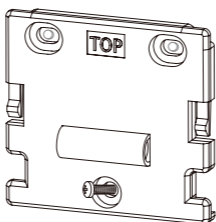

7. Adjust the Mounting Bracket using the built-in level. Once level, tighten the three screws.

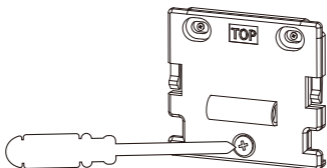

8. Place Cheego Camera over Mounting Bracket and press it down until it clicks.

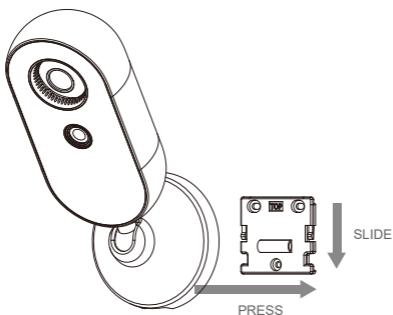

9. Organize the power cable, peel the tape backing off the Cable Covers, and firmly adhere the bottom of the cable covers to the wall.

Connect the power cable with the DC Power Adapter, plug the power adapter into your outlet. Make sure that the power outlet you use is not within your child's reach.

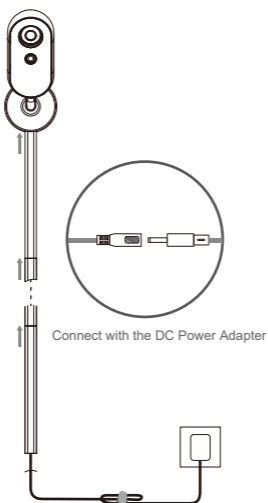

Organize the extra power cables with velcro.

INSTRUCTIONS

Get start Cheego Smart app

Download the Cheego Smart App from Apple Store or Google Play. Or scan the QR code in the user guide.



Download & Register
"Cheego Smart"APP

Boot

Please connect the camera with the power adapter. And the LED light will be automatically turned on and off.

Please wait about 35 seconds before the device boot up successfully.

GET START CHEEGO SMART APP

△ Cheego Smart APP will upgrade and update. The actual operation may be different from the above description. Please follow the instructions in the current version.

△ When connecting, please keep the network good and the monitor turned on. 5GHz Wi-Fi network is unavailable. Please set it to 2.4GHz first.

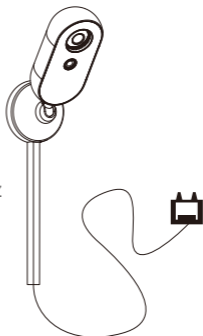

CHEEGO SMART APPLICATION SETUP GUIDE

- Download the Cheego Smart App and set up your account.
- Follow the in-app instructions to set up your Cheego Smart Camera. Choose: Homepage > Add your device > Scan QR code to connect>Pair succeed> Choose installation way> Choose installation position
- You can choose to follow the assembly instructions in-app or in this booklet.

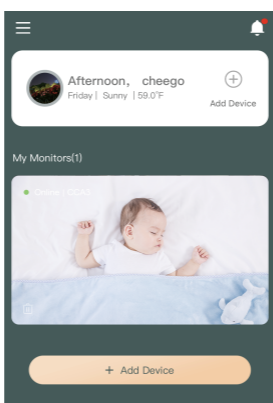

SPECIFICATIONS

Model	CCA3-W
Resolution	1296P
Lens	f=2.8mm / F2.0
Field of View	140° (Diagonal)
Connectivity	Wi-Fi 2.4GHz
Support System	Android 7.0 or IOS 11.0 or above
TF card	32GB
Mounting	Wall Mount (Standard Package) Floor Stand Mount (Need to Purchase a Replacement Floor Stand)
Power	DC12V / 1A
Working Temperature	0-40°C
Dimensions	90X90X215mm
Item Weight	420g

FEATURES

INTRODUCTION

Live Video And Two-Way Audio

Cheego 3MP ultra HD camera and high-quality speaker provide a fantastic connection with your baby anywhere and anytime.

Smart Thermometer

With built-in AI chip& sensor, Cheego uses advanced algorithm to realize ± 0.3 degrees high precision forehead temperature monitoring

Crying Detection& Soothing Music

Cheego baby monitor automatically plays soothing musics& turns on the night lamp (at night), and sends alarm messages to the APP when it detected baby's crying.

Sleep Nanny

Cheego captures and analyzes baby's sleep with AI technology in real time, and sends alarm messages to the APP if your baby wakes up.

Moments

Cheego uses an advanced algorithm to capture photos and videos of baby's wonderful moments. Record your baby's precious time.

Virtual Fence Detection

Cheego sends instant notifications through the APP when the baby is out of the virtual fence.

Danger Zone Detection

Set the electronic area as the danger zone, when baby enters the danger zone, Cheego provides voice warning and sends alarm messages to the APP.

Temperature and Humidity Detection

Embed high precision temperature& humidity sensor, Cheego checks the room temperature and humidity in real time to make baby more comfortable.

Non-Invasive Night Vision

Non-invasive infrared sensor makes clear vision in the dark.

FAQ

WiFi cannot be connected when configuring the network (configuration is not successful)

Setup routers to a 2.4GHz Wi-Fi network

I don't hear the connection succeeded when I scan QR code

QR code cannot be recognized, the possible reasons are as follows:

- 1). Screen is too dark
- 2). Too far or too close from the lens
- 3). Reflection

Suggestions:

- 1). The phone screen is facing the lens
- 2). Adjust phone screen brightness
- 3). Adjust the distance between the phone and the lens

What should I do if the camera goes offline (device icon gray)?

Suggestions:

- 1). Shut down and reboot your device
- 2). If the Wi-Fi was changed, please follow the RESET instruction to reset your camera.

What should I do if I can't connect my device after the upgrade?

The possible reasons are as follows:

- 1). Check the WiFi network
- 2). Shut down and reboot your device
- 3). Re-setup the device (After the device is powered on, scan reset QR code within ten minutes) , rebind the device.

What should I do if the call has an echo?

When making a call, please try to keep the mobile phone more than 10 meters away from the device. The echo and howling caused by the short distance call is a normal phenomenon.

What should I do if mobile phone cannot receive the notification?

Go to mobile "setting"→"Cheego smart"→"Allow notification"

What should I do if body temperature check failed?

Suggestion:

- 1). When temperature measurement starts, a red circle will appear in your phone screen. Make sure your baby's forehead is in the circle and stillness
- 2). Please confirm that the working environment of the equipment is 0-40 °C. Ambient temperatures that are too low or too high can affect the accuracy of the measurement and cause the temperature measurement to fail.
- 3). Before temperature measurement, if there is a temperature difference between the monitor and the measurement environment, please leave the monitor for at least 50 minutes.

How to RESET the camera?

press the RESET button on the camera with 5 seconds, click "Reset Device Step by Step" in Cheeg Smart APP, then do it step by step

GUARANTEE & WARRANTY

SATISFACTION GUARANTEE & RETURN POLICY

Thank you for purchasing Cheego products. If you are not completely satisfied with your purchase, you may return the product for a full refund within 30 calendar days of setting up a hardware product (icheego.com) or within 15 days of activating an online product (Cheego authorized online reseller). This satisfaction guarantee requires proof of purchase from an authorized seller. Purchases from 3rd party retailers will need to be returned to the original place of purchase.

LIMITED WARRANTY

This limited warranty contains important information about your rights and obligations, as well as limitations and exclusions that may apply to you.

This limited warranty only applies if you are the original purchaser, use and operate the product in the United States or Canada. Please note if you are not resident of the United States or Canada, this Limited Warranty & Return Policy does not apply to you.

PRODUCTS OBTAINED FROM UNAUTHORIZED RETAILERS ARE NOT COVERED BY THIS LIMITED WARRANTY.

Please be aware that there are some retailers and websites that claim to be authorized retailers of Cheego when they are not. Note that when you purchase from these unauthorized retailers, you are taking a risk, including a risk that these products are used or defective, and this limited warranty will not apply.

1.WHAT THIS LIMITED WARRANTY COVERS?

Period of coverage. Warrants to the owner of the enclosed product that the product contained in this box ("Product") will be free from defects in materials and workmanship for a period of one (1) year from the date of delivery following the original retail purchase (the "Warranty Period"). If you believe you have received a defective product, we will either repair or replace the defective product or its defective component part(s) in accordance with the terms of this limited warranty. We warranty replacement for the remaining unexpired period of the original product's warranty. This limited warranty is the only warranty available for our products.

2.WHAT THIS LIMITED WARRANTY DOES NOT COVER?

- Products marked as “sample” or “Not for Sale”, or sold “AS IS”;
- Ineligible Products that have been subject to:
 - (a) Modifications, alterations, tampering, or improper maintenance or repairs;
 - (b) Handling, storage, installation, testing, or use not in accordance with the Terms of Service or other instructions provided by Cheego;
 - (c) Abuse or misuse of the Product;
 - (d) Damages caused by Acts of God, including but not limited to lightning, flood, tornado, earthquake, or hurricane;
- Consumables parts, including but not limited to batteries, unless damage is due to defects in materials or workmanship of the product;
- You use unauthorized service providers for maintenance or repair;
- Unauthorized use of the Product or software can impair the Product’s performance;
- This limited warranty does not warrant to covered any software, even if packaged or sold with the Products;
- Refer to the licensing agreement accompanying the software for details of your rights with respect to its use;
- This limited warranty does not warrant that the operation of the product will be uninterrupted or error-free;
- This warranty cannot be transferred from the original end-user to others for any such transfer.

3.NOT A MEDICAL DEVICE.

The products are not medical devices and are not intended to be used as a medical devices.

4.DISCLAIMER OF WARRANTIES.

EXCEPT AS STATED ABOVE IN SECTION 1 OF THIS LIMITED WARRANTY, AND TO THE MAXIMUM EXTENT PERMITTED BY APPLICABLE LAW, CHEEGO DISCLAIMS ALL

EXPRESS, IMPLIED, AND STATUTORY WARRANTIES AND CONDITIONS WITH RESPECT TO THE PRODUCT, INCLUDING THE IMPLIED WARRANTIES OF MERCHANTABILITY, FITNESS FOR A PARTICULAR PURPOSE AND NON-INFRINGEMENT. TO THE MAXIMUM EXTENT PERMITTED BY APPLICABLE LAW, CHEEGO ALSO LIMITS THE DURATION OF ANY APPLICABLE IMPLIED WARRANTIES OR CONDITIONS TO THE DURATION OF THIS LIMITED WARRANTY. FOR THE AVOIDANCE OF DOUBT, NOTHING IN THIS CLAUSE 6 IS INTENDED TO EXCLUDE ANY WARRANTIES OR GUARANTEES WHICH CANNOT BE EXCLUDED UNDER APPLICABLE LAWS.zz

5.YOUR RIGHTS AND THIS LIMITED WARRANTY.

WE LIMIT THE APPLICABILITY OF IMPLIED WARRANTIES, INCLUDING THE IMPLIED WARRANTIES OF MERCHANTABILITY AND FITNESS FOR A PARTICULAR PURPOSE, TO THE DURATION OF THIS LIMITED WARRANTY. TO THE EXTENT PERMITTED BY LAW, WE DISCLAIM ALL OTHER WARRANTIES OF ANY KIND. SOME STATES AND COUNTRIES DO NOT ALLOW LIMITATIONS ON IMPLIED WARRANTIES, SO THE ABOVE LIMITATION MAY NOT APPLY TO YOU. OUR SOLE LIABILITY FOR ANY DEFECT SHALL BE AS SET FORTH IN THIS LIMITED WARRANTY AND EXCLUDES ANY CLAIMS FOR INCIDENTAL OR CONSEQUENTIAL DAMAGES. SOME STATES AND COUNTRIES DO NOT ALLOW THE EXCLUSION OR LIMITATION OF INCIDENTAL OR CONSEQUENTIAL DAMAGES, SO THE ABOVE LIMITATION ENTITY IS AUTHORIZED TO MAKE ANY OTHER WARRANTY ON OUR BEHALF. THIS WARRANTY GIVES YOU SPECIFIC LEGAL RIGHTS. YOU MAY ALSO HAVE OTHER RIGHTS WHICH VARY FROM STATE TO STATE AND COUNTRY TO COUNTRY. OR EXCLUSION MAY NOT APPLY TO YOU. NO PERSON OR

COMPLIANCE



DECLARATION OF CONFORMITY

Hereby, Hangzhou Cheego Technology Co., Ltd. Room 603, Bldg. E2, 3# Xiyuan 8 Road, Hangzhou, 310030, China, declares that the equipment Model CCA3 is in compliance with Directive 2014/53/EU.

PRODUCT USE WARNING

This product is meant for indoor use only.

RADIO FREQUENCY (RF) EXPOSURE STATEMENT

This equipment should be installed and operated with a minimum distance of 20 cm between the camera and the human body.



This symbol means the product must not be discarded as household waste, and should be delivered to an appropriate collection facility for recycling. Proper disposal and recycling helps protect natural resources, human health and the environment. For more information on disposal and recycling of this product, contact your local municipality, disposal service or the shop where you bought this product.